

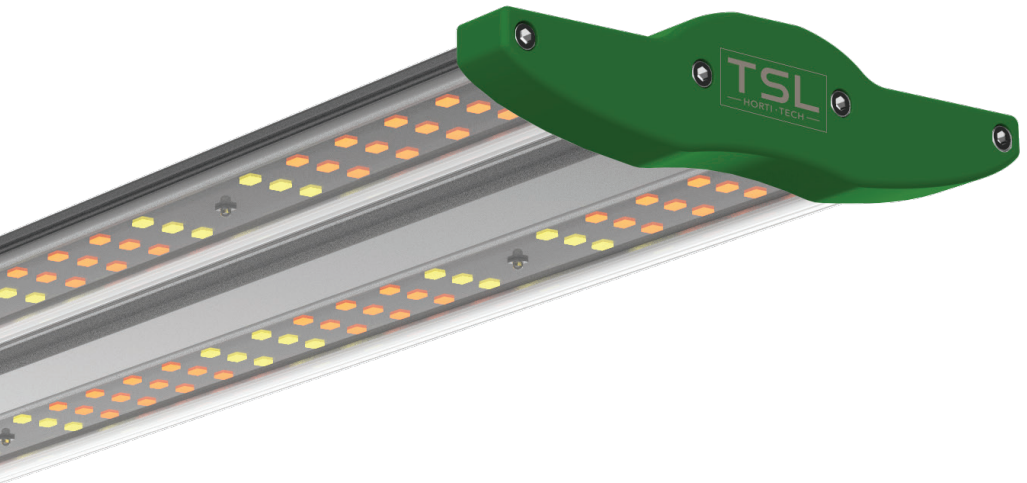

GROWER'S CHOICE
HORTICULTURAL LIGHTING



PFS-SERIES

LED USER MANUAL

Installation and Operating Instructions



**PLEASE READ
THESE INSTRUCTIONS
BEFORE USING
THE PRODUCT**



INTRODUCTIONS:

Thank you for purchasing the PFS Horticulture LED System. An inspired collaboration between two of the most respected lighting companies in horticulture industry. TSL Horti Tech and Grower's Choice have joined forces with their years of innovative experience to create this high performance and cost-effective lighting solution for commercial horticulture.

**TECHNICAL
SPECIFICATIONS:**

SPECIFICATIONS (SINGLE PANEL)	
Light Source	LED
Spectrum	GC-3K Full Phase
PPF	100 μmol/s
Input Power	40W
Efficacy	2.5 μmol/s
Fixture Dimension Weight	47.2x5.1x1.5 inch 2.2lbs 1199x130x38 mm 1.0kg
Mounting Height	≥6" (15.2cm) Above Canopy
Thermal Management	Passive
Light Distribution	120°
Lifetime	L90: >54,000 hrs
Power Factor	>90%
Certifications	IP65, ETL, CE
Warranty	3 Years Standard Warranty

MAX AMPERAGE BY VOLTAGE SERVICE

VOLTAGE	120V	208V	240V	277V
AMPERAGE	0.345A	0.197A	0.173A	0.154A

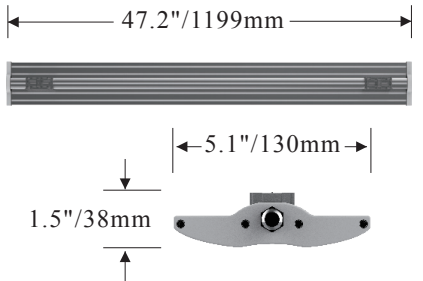
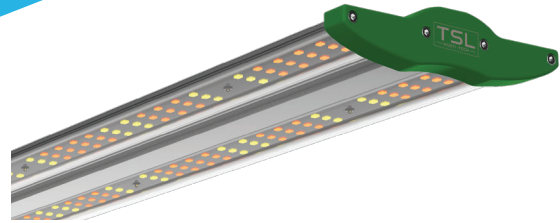

* PPF calculations complied using our in-house integrating sphere measurements and typical spectroradiometric data for each LED to determine the fixture performance. Actual photometric results may vary within the LED's manufacturer's bin tolerance.

* Wattage values are typical expected values. TSL Horti Tech maintains a tolerance of +/- 10% range on flux and power consumption. Target light level can vary from projected levels depending on ambient temperature, room reflections values, and other conditions.



SAFETY WARNINGS:

The PFS series LED system is passively cooled with absolutely no moving components. Do not try to open or disassemble the fixture, it contains no service parts inside. Doing so may cause harm to the fixture and void warranty.

- Always adhere to the local rules and regulations when installing or using the fixture.
- Wearing protective gloves and glasses is recommended during installation.
- Always disconnect from the mains before performing any maintenance to the fixture.
- The fixture will get hot during operation. Do not touch while the light is on. Keep this product away from children.
- Always allow at least 10 minutes for the fixture to cool down before handling.
- Do not touch the LED diodes.
- Keep the power cord away from hot surface.
- Do not plug this system into a supply voltage other than what is instructed on the fixture.
- Do not use the fixture when the power cord is damaged.
- Do not use the fixture when the unit has been dropped, or its enclosure or bars are damaged.



WARNING

Risk of electrical shock. To reduce the possibility of serious injury, always take the proper precautions and unplug the fixture before moving or cleaning.

WARNING

Light bars and power supply are splash-proof but not waterproof. In the event that the light bar becomes submersed, first disengage the circuit breaker, then unplug the fixture before proceeding to remove from water.



CAUTION

To reduce the risk of overheating or fire, never place operating fixtures face down on a flush surface. Always allow for adequate ventilation of fixtures and power supplies.

CAUTION

LED and heat sink surfaces may be hot. Allow sufficient cooling time before handling.

CAUTION

To prevent eye damage, avoid looking directly at the unshielded LEDs.

CAUTION – RISK OF PERSONAL INJURY

Disconnect power before servicing or installing luminaire. Lighted fixture may be hot. To reduce risk of injury, turn off or disconnect power and allow to cool before handling. Fixture must be grounded in accordance with appropriate codes. Failure to do so may result in serious injury or death. Be sure all power is off prior to installing fixture.

ACCESSORIES

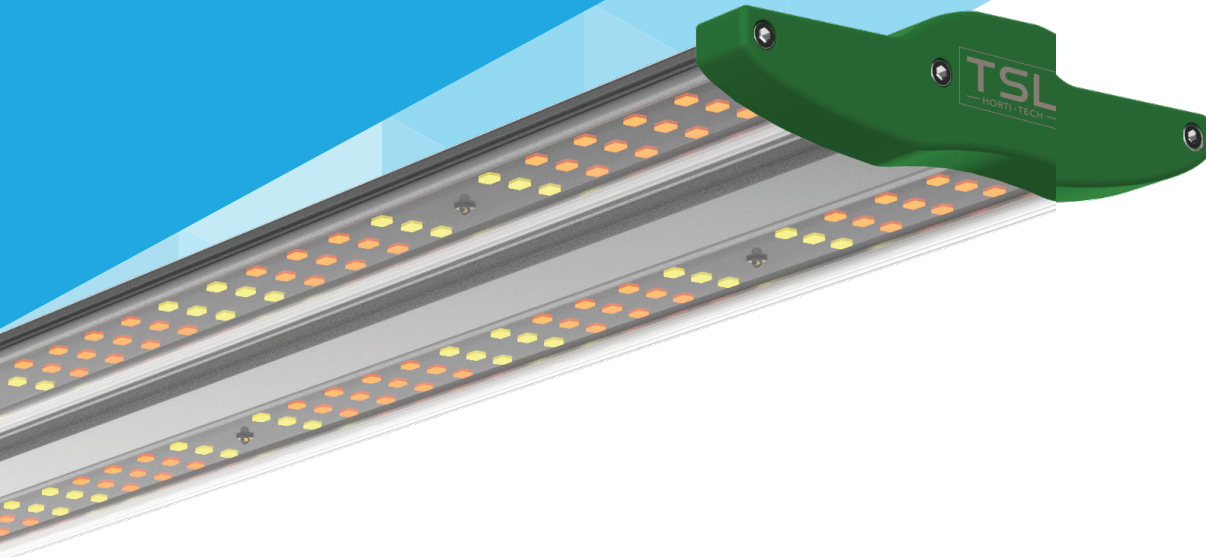

CONTENTS:

- PFS LED Panel x4
- 8' Power Cord x1
- 120V/240V Plug Adaptor x1
- Four-in-One Cable x1
- Assembly Package x4
- User Manual

Not Included:

- Carabiner Cables
- Glasses



Assembly Package



Four-in-One Cable

INSTALLATION:



- Switch off mains power
- We always recommend using certified or qualified installation professional to ensure optimal performance and safety.



- Unbox fixture and place on flat, stable surface.

1. Surface mounted

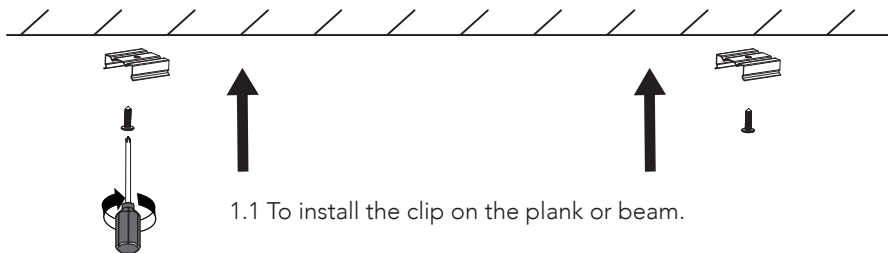

1.1 To install the clip on the plank or beam.

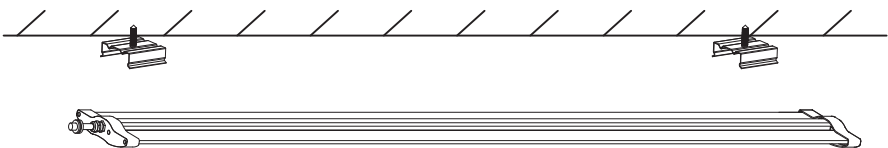

1.2. To clasp the light on the clip.



1.3. Completed lamp assembly diagram.

2. Pendant

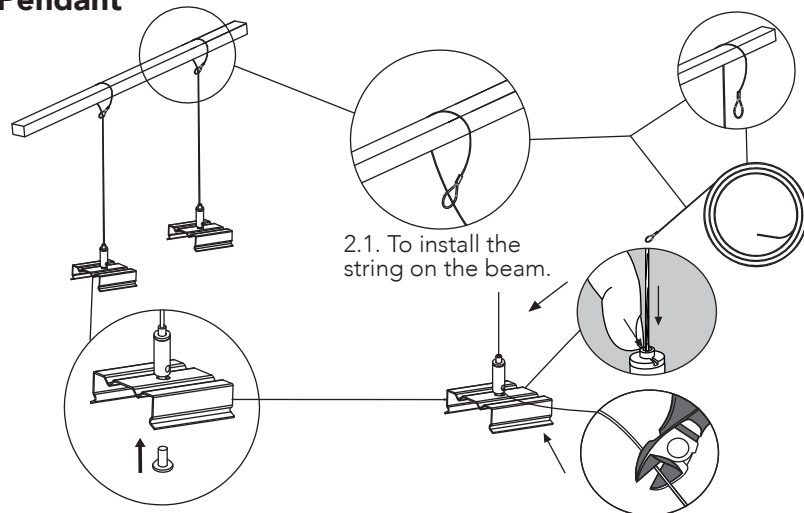

2.1. To install the string on the beam.

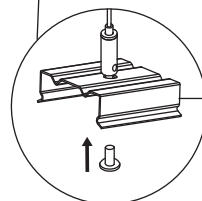

2.2. To install the adjustable kit and clip.

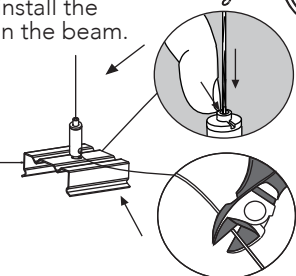

2.3. To adjust the height of the lamp and cut the rest part of the string.

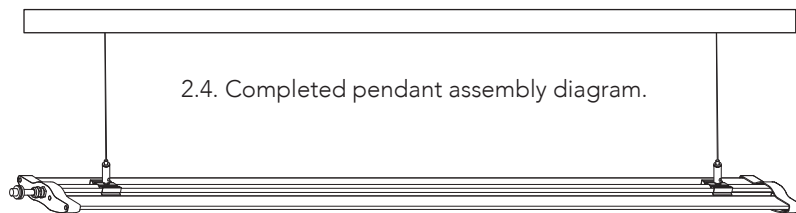

2.4. Completed pendant assembly diagram.

WARRANTY:

Grower's Choice warrants the mechanical and electronic components of their product to be free of defects in material and workmanship if used under normal operating conditions for a period of three (3) years from the original date of purchase. If the product shows any defects within this period and that defect is not due to user error or improper use, Grower's Choice shall, at its discretion, either replace or repair the product using suitable new or reconditioned products or parts. Grower's Choice warranty liability extends only to the replacement cost of the product. In Grower's Choice decides to replace the entire product, the limited warranty shall apply to the replacement product for the remaining initial warranty period.

Grower's Choice shall not be held responsible for any damage caused by the operation of the unit, be it incidental or consequential or any type including, without limitation, damage or injury caused to other products or machinery or buildings. Nor will responsibility be accepted for loss of time or profit, loss of finished product, or for any inconvenience caused in any way whatsoever.





Tel: (909) 972-8419

E-mail: info@growersc.com

Website: www.growersc.com

Address: 2249 S Yale St, Santa Ana, CA 92704

